



Lighting
DAILY COLLECTION

la murrina
M U R A N O

la murrina
M U R A N O

Indice Index

Pag.	
16	602
18	629
26	655
14	681
20	684
22	688
7	697
12	702
10	ALBATROS
8	ALDEBARAN
24	FILE`
28	GRAFFIO
30	SPECCHIO BURANO
6	SQUARED
14	TETI

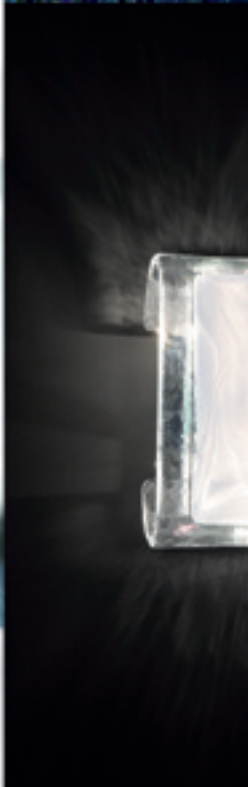
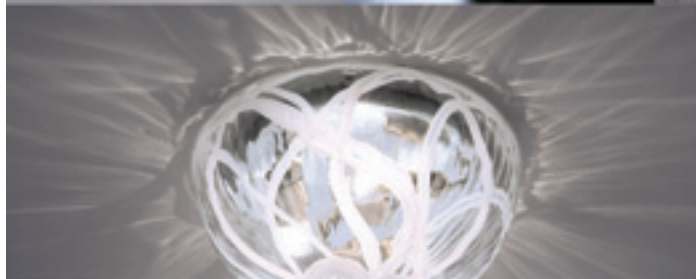
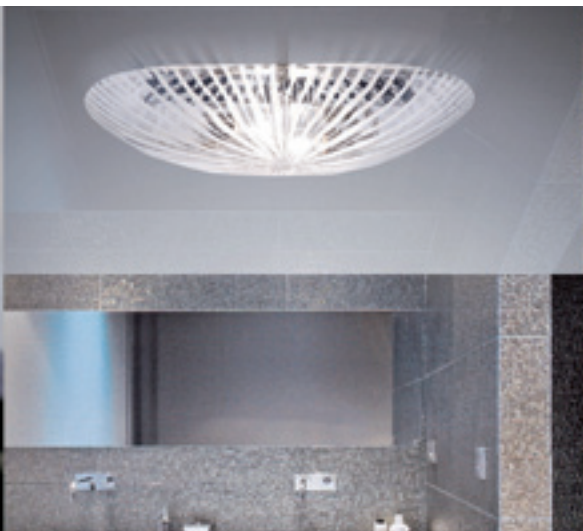



DAILY COLLECTION

Una selezione di lampade e sculture luminose dedicate all'abitare contemporaneo, dove predominano linee sobrie e pulite.

Varie soluzioni di illuminazione per ambienti domestici e destinati alla collettività, il cui ruolo è quello di decorare e personalizzare gli spazi attraverso effetti di trasparenze e colori.

Our Contemporary Design collection contains a selection of chandeliers, sconces, lamps and lighted sculptures that have been designed with today's sleek, modern environments top of mind.

Whether for commercial or residential interior spaces, this collection offers an expansive selection of works, which will personalize any space with color, shape and texture.

SQUARED

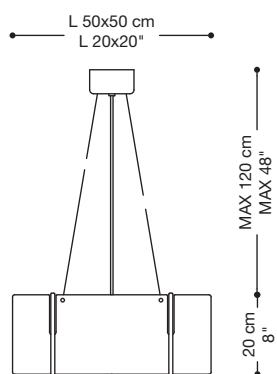

S |  1 x MAX 100W E27 ES |  IP 20 230V  



Squared S

Vetro/Glass

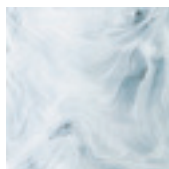

DD

Struttura/Metalwork



3S

697

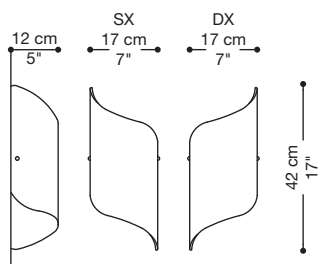

A/AL | 1 x MAX 100W E27 ES | IP 20 230V



697 A

Vetro/Glass



DD

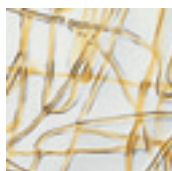

HB

Struttura/Metalwork



3L

ALDEBARAN

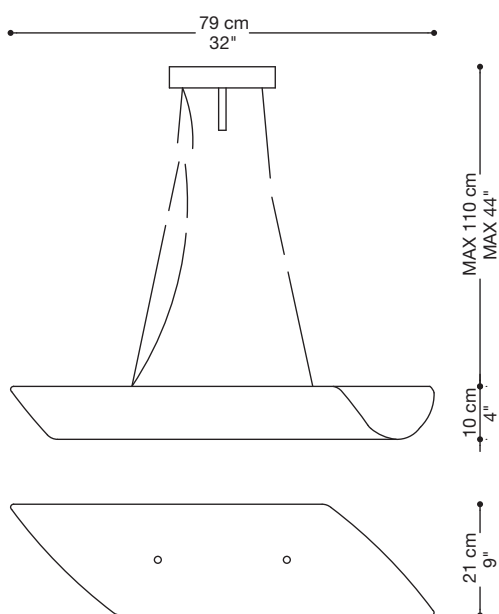

R/S |  2 x MAX 100W E27 ES |  IP 20 230V  

Vetro/Glass



HB

Struttura/Metalwork







3S

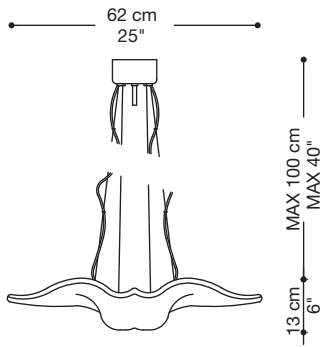

Aldebaran S/R

ALBATROS



R/S AL 62 |  1 x MAX 230W AL R7s ES |  (0.3m) IP 20 230V  

Vetro/Glass



DA

Struttura/Metalwork



3S



702

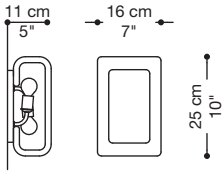

A |  2 x MAX 28W E14 ES

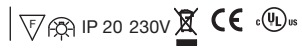

Vetro/Glass
702

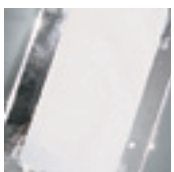

AD

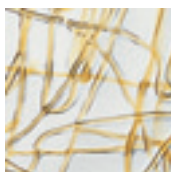

HB

Struttura/Metalwork

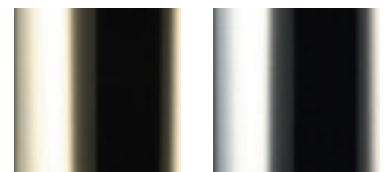

2L

3L



681

TETI

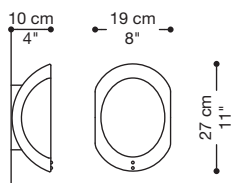

A | 2 x MAX 28W E14 ES

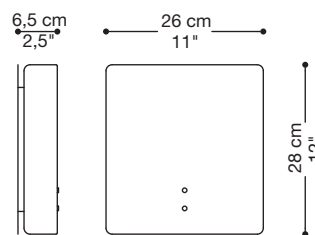

TETI A | 2 x MAX 28W E14 ES | IP 20 230V | CE cUL US

Vetro/Glass
681



AD

Struttura/Metalwork

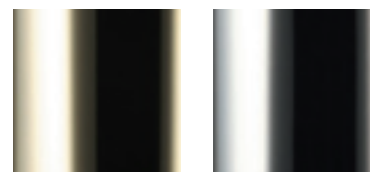

2L

3L

Vetro/Glass
Teti

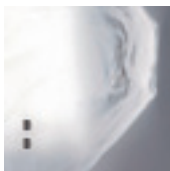

DD

Struttura/Metalwork



3S



681 A



Teti A

602

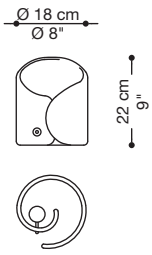

P | 1 x MAX 28W E14 ES |   IP 20 230V  

Vetro/Glass



AD



HB

Struttura/Metalwork

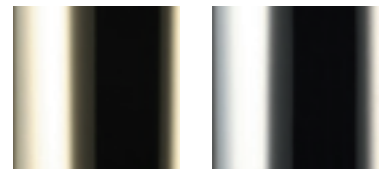

2L

3L



629

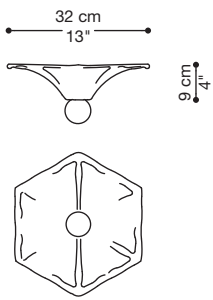

R/32 |  1 x MAX 100W E27 ES |  IP 20 230V  

Vetro/Glass

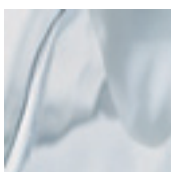

AD

Struttura/Metalwork

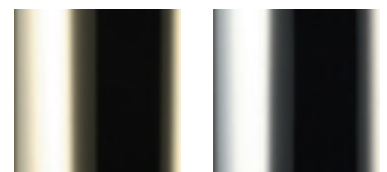

2L

3L



629 R

684

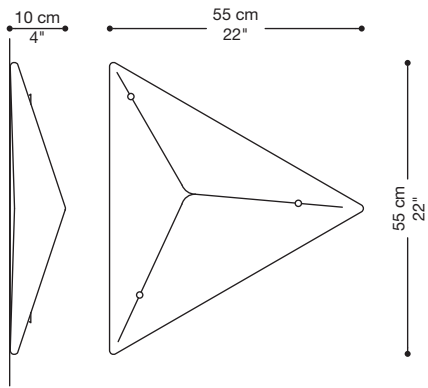

684 A/R 55 | 3 x MAX 28W E14 ES | IP 20 230V | CE cULus

Vetro/Glass

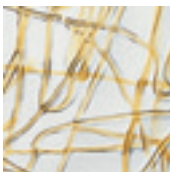

HB



HD

Struttura/Metalwork

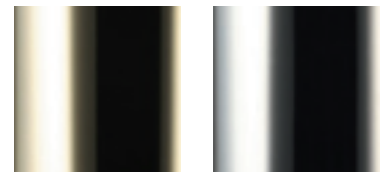

2L

3L



684 A/R

688

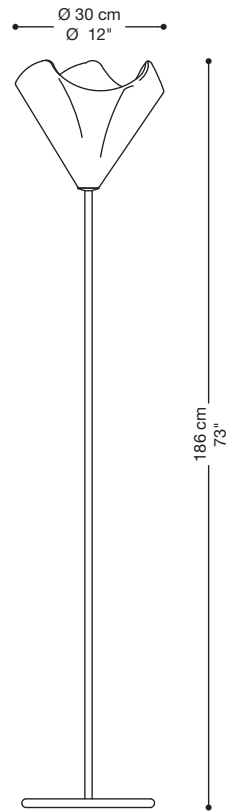
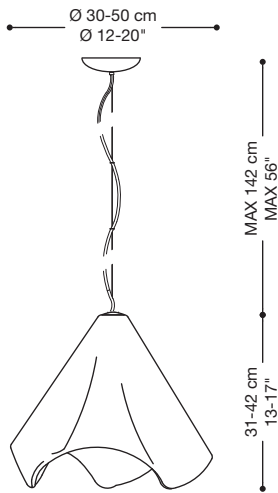

S/Ø 30 | 1 x MAX 100W E27 ES | IP 20 230V

Ø 50 | 1 x MAX 100W E27 ES

T/AL | 1 x MAX 100W E27 ES | IP 20 230V

Vetro/Glass

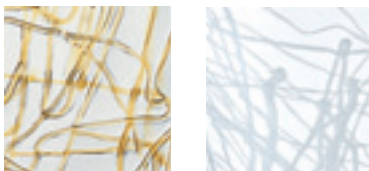

HB

HD

Struttura/Metalwork

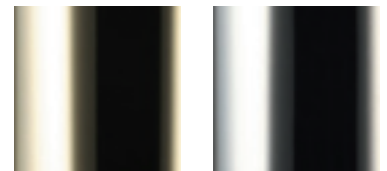

2L

3L



688 S



688 T

FILE

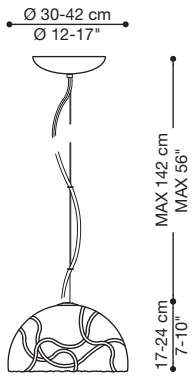

S/Ø 30-42 | 1 x MAX 100W E27 ES

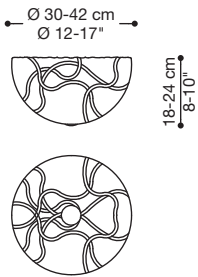
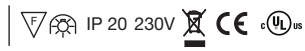

R/Ø 30-42 | 3 x MAX 28W E14 ES

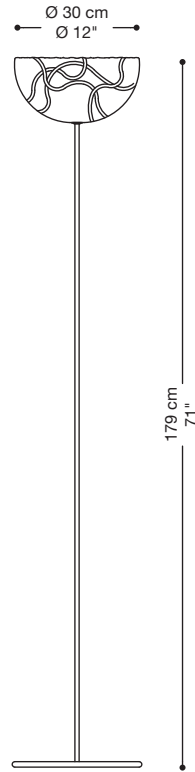

T/AL | 1 x MAX 100W E27 ES



Vetro/Glass



AD

Struttura/Metalwork

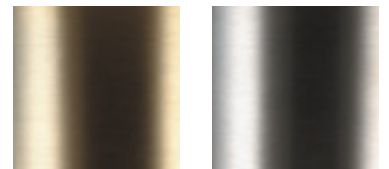

2S

3S



655

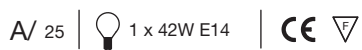
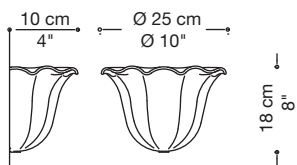
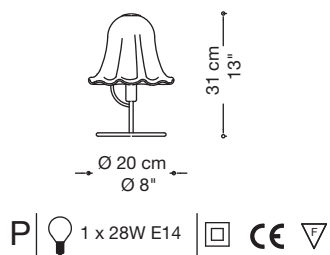
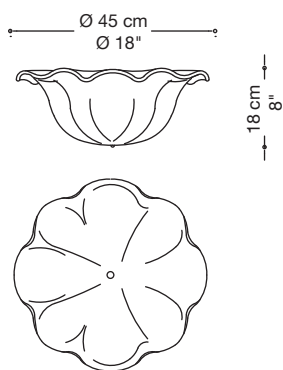

Vetro/Glass

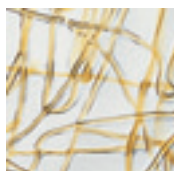

HB

Struttura/Metalwork



2L

3L



655 R



655 P

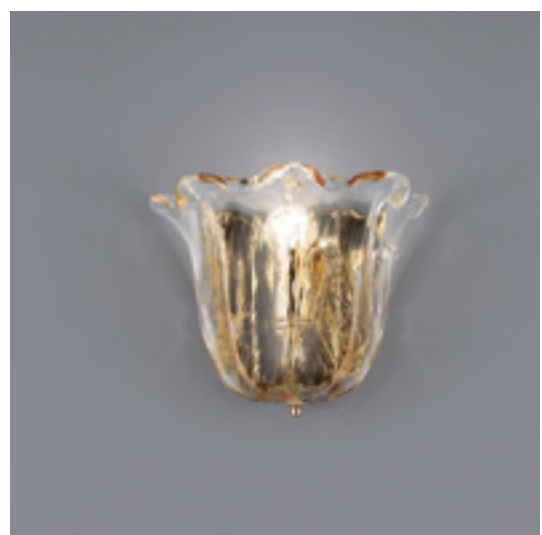

655 A

GRAFFIO

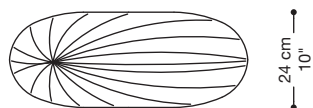
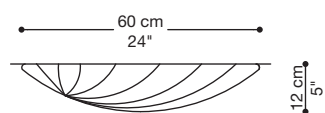

R |  2 x MAX 70W E27 ES |  IP 20 230V  

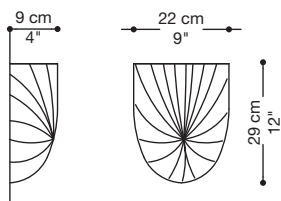

A /22 |  2 x MAX 42W E14 ES |  IP 20 230V  

Vetro/Glass

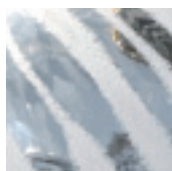

QD

Struttura/Metalwork



3S



Graffio R



Graffio A

SPECCHIO BURANO

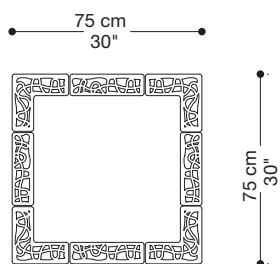

Vetro/Glass



AA

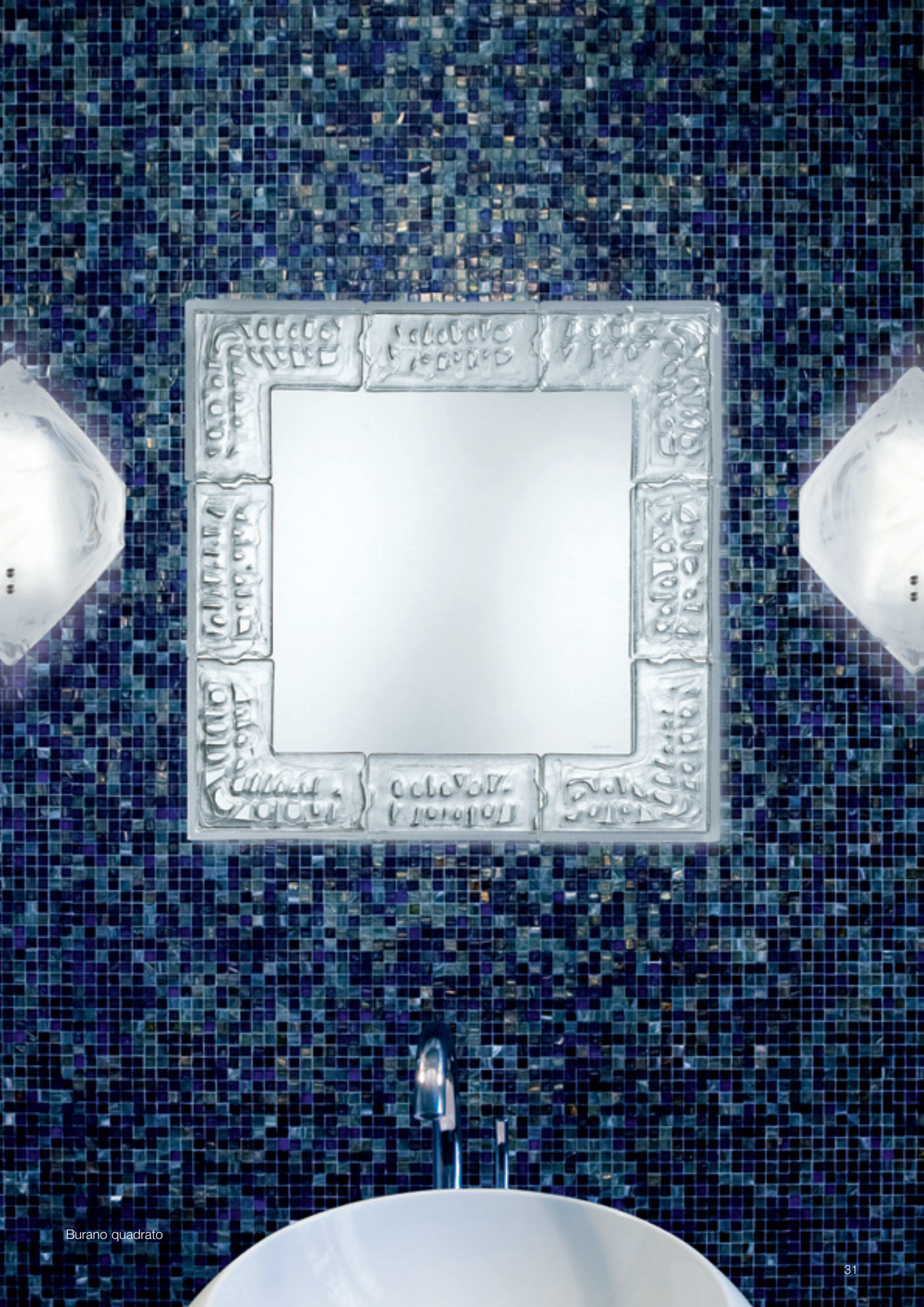

Burano quadrato

La riproduzione in qualsiasi formato di questo catalogo o di parte di esso è assolutamente proibita senza la previa autorizzazione scritta di **la murrina®**.

Il logo **la murrina®** è di esclusiva titolarità e proprietà di **la murrina®**.

Non può essere riprodotto né usato per scopi commerciali, senza il consenso scritto di **la murrina®**.

L'azienda si riserva di modificare, in qualsiasi momento e senza nessun preavviso, le caratteristiche tecniche dei prodotti illustrati in questo catalogo.

la murrina® declina ogni responsabilità per eventuali errori di stampa presenti nel catalogo.

la murrina® lavora scrupolosamente con i designer e lo staff tecnico e ingegneristico per garantire sempre un elevato standard qualitativo per ogni singolo pezzo della propria produzione.

I materiali scelti e la componentistica elettrica sono di prima qualità. L'assemblaggio e il controllo viene eseguito in maniera rigorosa da manodopera specializzata.

La produzione del vetro soffiato può presentare alcune minime differenze di peso, colore o spessore, dovute alla elaborazione artigianale dei pezzi. Le eventuali bolle e irregolarità presenti nell'impasto non sono difetti ma caratteristiche preziose ed uniche del vetro soffiato e lavorato a mano artigianalmente.

Ogni corpo illuminante è corredato con una busta contenente un foglio di istruzioni e modalità di assemblaggio.

Modifiche e/o riparazioni di qualsiasi natura apportate al prodotto non autorizzate dopo l'acquisto o il mancato rispetto delle istruzioni di montaggio, possono compromettere la sicurezza del prodotto stesso e provocare situazioni di pericolosità per l'utente.

Pertanto **la murrina®** ne declina ogni responsabilità.

Le dimensioni riportate nei disegni tecnici dei prodotti sono espressi in centimetri e pollici.



Legenda simboli



La marcatura CE indica che il prodotto soddisfa gli obblighi di legge in merito alle Direttive Comunitarie Europee applicabili allo stesso.



La marcatura UL indica che il prodotto soddisfa gli obblighi di legge in merito alle Direttive del mercato nordamericano applicabili allo stesso.



Apparecchio installabile direttamente su superfici normalmente infiammabili.



Lampada alogena autoprotetta.

IP 20

GRADO DI PROTEZIONE IP20:
Apparecchio ordinario (nessun segno grafico).



CLASSE DI ISOLAMENTO II:
All'isolamento fondamentale è aggiunto un secondo isolamento o, ai due isolamenti è sostituito un isolamento rinforzato.
Messa a terra: ESCLUSA.



CLASSE DI ISOLAMENTO III: Alimentazione effettuata con bassissima tensione di sicurezza, tensioni superiori a 50 Volt (a 50Hz) sono escluse in ogni parte.
Messa a terra: ESCLUSA.



Distanza minima dagli oggetti illuminati.



Divieto d'uso di lampade a luce fredda.



Foro nel soffitto.

Symbols list

The CE symbol is your assurance that the product bearing the mark meets all the requirements prescribed by law, as contained in the European Community Directives which apply to that products.

The UL symbol is your assurance that the product bearing the mark meets all the requirements prescribed by law, as contained in the North American Directives which apply to that products.

Fixture ready for mounting on normally flammable surface.

Self-shielded halogen lamp.

DEGREE OF PROTECTION IP20:
Ordinary fixtures (no symbols).

CLASS INSULATION II:
Basic insulation plus second insulation or both replaced by reinforced insulation.
Grounding: EXCLUDED.

CLASS INSULATION III: Very low safety supply voltage, not to be used at over 50V (at 50Hz).
Grounding: EXCLUDED.

Minimum distance from illuminated objects.

Warning against the use of cool-beam lamps.

Hole on the ceiling.

Codici colori Glass colour codes

- AA** Cristallo Transparent
- AD** Cristallo bianco Transparent white
- DA** Bianco cristallo White transparent
- DD** Bianco White
- HB** Graffito topazio Topaz graffito
- HD** Graffito bianco White graffito
- QD** Granigliato bianco White granigliato

Codici struttura Metalwork codes

- 2S** Oro satinato Matt gold
- 2L** Oro lucido Polished gold
- 3S** Nickel satinato Matt nickel
- 3L** Nickel lucido Polished nickel

Legenda

- S Sospensione/lampadario
- A Applique/lampada da parete
- P Lampada da tavolo
- R Plafoniera/lampada a plafone
- T Lampada da terra

Per alcune collezioni, gli abbinamenti di colore vetro - montatura sono predefiniti.

Eventuali modifiche e/o abbinamenti, andranno richieste per approvazione e preventivo.

la murrina si riserva di apportare in qualsiasi momento e senza preavviso, ai propri articoli modifiche tecniche ed estetiche che, a suo insindacabile giudizio, ritenga necessarie ai fini di migliorare il prodotto.

Non si garantisce che i prodotti forniti, corrispondano esattamente per forme, colori e misure alle foto presenti nel catalogo; eventuali variazioni sono da considerarsi caratteristiche e pregi della lavorazione artigianale del vetro di Murano.

Ogni prodotto si avvale di specifiche istruzioni di montaggio, inoltre tutti gli articoli riportati in catalogo sono conformi ai requisiti di sicurezza emanati dalle direttive europee e sono quindi a marchio CE.

la murrina garantisce l'originalità del suo prodotto inserendo su ogni prodotto la propria firma.

Legend

- S Chandelier/suspended lamp
- A Wall lamp
- P Table lamp
- R Ceiling lamp
- T Floor lamp

For some collections, the glass-metalwork colour combinations are predetermined.

Requests for modifications and/or different combinations must be submitted for approval and quotation.

la murrina reserves the right to modify its products technically and/or aesthetically, at any time without previous notice, whenever it believes necessary to improve the product.

We do not guarantee that the products will exactly correspond in form, colour, or size to the pictures shown in the catalogue. Possible variations are to be considered part of the value of the artisan workmanship of Murano blown glass.

Each product is delivered with specific mounting instructions; furthermore all the articles listed in the catalogue comply with European safety regulations and therefore are CE certified.

la murrina guarantees the originality of its products by putting its signature on each item.

la murrina
M U R A N O

Direzione: Via Isonzo 26 22078 Turate (CO) Italy
Tel: +39.02.969 75 1 Fax: +39.02.969 75 212
Fornace: Riva Longa 17 Murano Venezia Italy

www.lamurrina.com

